

FLOOR BOXES

Technical Specification

Product Code: FB4C

Description: 3/4 Compartment ABS Cavity Floor Box With Adjustable Depth

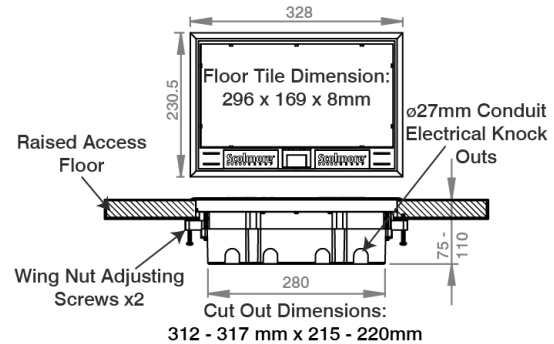

General Information

Dimensions	328mm (W) x 230.5mm (H) x 75mm-110mm (D)
Cut-out Dimensions	312mm-317mm (W) x 215mm-220mm (H)
Minimum Floor Thickness	10mm
Maximum Floor Thickness	45.5mm
Inset Tile Dimensions	296mm x 169mm x 8mm
Trim Finish	Graphite Grey
Materials	Top Frame, Lid, Handle & Base: ABS Top Support & Lid Infill: Galvanised Steel Plate Holder & Segregation Wall: Galvanised Steel Closure Spring: Spring Steel
Accessory Plates	179mm x 89mm (3) or 179mm x 67.5mm (4)
Plug Height	43mm Max.
Removeable Cover	Yes (Spring Retaining Arms)
Ingress Protection	IP20
Available Knockouts	Side: 12 x 22mm, Base: 8 x 27mm (To Accept Flexible Conduit)

Standards IEC 60670-23: 2006+A1:2016

Additional Information

Ensure that the mains supply is isolated before commencing installation and refer to the circuit diagram with the relevant product.
Bare earth cables must always be covered with appropriate sleeving and wired to the earth terminal.

FLOOR BOXES

Technical Specification

Product Code: FB4C

Description: 3/4 Compartment ABS Cavity Floor Box With Adjustable Depth

Compatible Plates

Finish Graphite Grey
 Insert Colour White

Suitable For 3 x Accessory Plates Dimensions: 179mm (W) x 89mm (H)

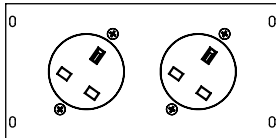

FBI010
 UK x2 13A CIRCULAR SOCKET

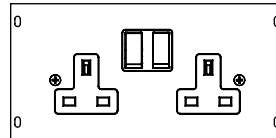

FBI036/ FBIST036
 UK 2G 13A SWITCHED SOCKET
(DOUBLE POLE)

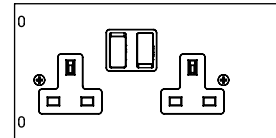

FBIL036/ FBILST036
 UK 2G 13A SWITCHED SOCKET
-LEFT HANDED (DOUBLE POLE)

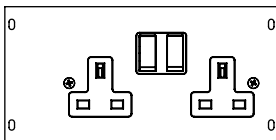

FBIR036/ FBIRST036
 UK 2G 13A SWITCHED SOCKET
-RIGHT HANDED (DOUBLE POLE)

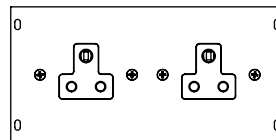

FBI038
 X2 5A UNSWITCHED
 ROUND PIN SOCKET

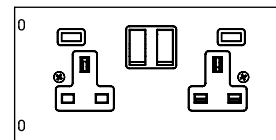

FBI780
 UK 2G SWITCHED SOCKET
 WITH USB



FAP061
 BLANKING PLATE

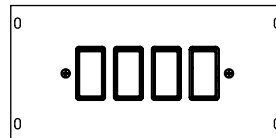

FBI20404
 GRID PRO SWITCH PLATE x4

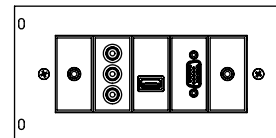

FBI316
 NEW MEDIA PLATE x5

Suitable For 4 x Accessory Plates Dimensions: 179mm (W) x 67.5mm (H)

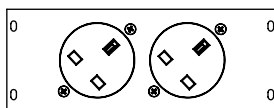

FB4I010
 UK x2 13A CIRCULAR SOCKET

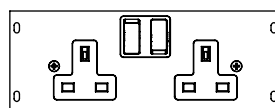

FBI4036/ FBI4ST036
 UK 2G 13A SWITCHED SOCKET
(DOUBLE POLE)

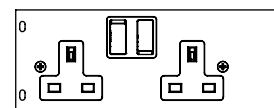

FBI4L036/ FBI4LST036
 UK 2G 13A SWITCHED SOCKET
-LEFT HANDED (DOUBLE POLE)

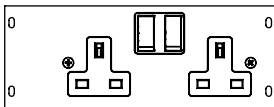

FBI4R036/ FBI4RST036
 UK 2G 13A SWITCHED SOCKET
-RIGHT HANDED (DOUBLE POLE)

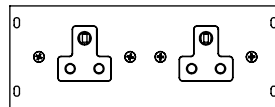

FB4I038
 X2 5A UNSWITCHED
 ROUND PIN SOCKET

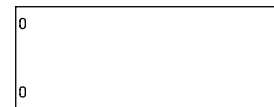

FAP4061
 BLANKING PLATE

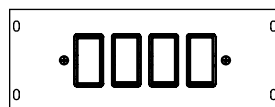

FBI420404
 GRID PRO SWITCH PLATE x4

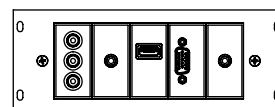

FBI4316
 NEW MEDIA PLATE x5