

FLOOR BOXES

Technical Specification

Product Code: FB2C

Description: 2 Compartment ABS Cavity Floor Box With Adjustable Depth

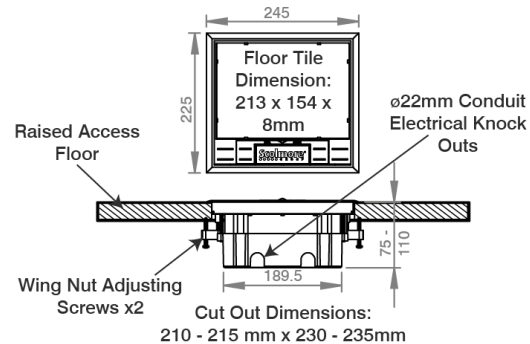

General Information

Dimensions	245mm (W) x 225mm (H) x 75mm-110mm (D)
Cut-out Dimensions	230mm-235mm (W) x 210mm-215mm (H)
Minimum Floor Thickness	10mm
Maximum Floor Thickness	45.5mm
Inset Tile Dimensions	213mm x 154mm x 8mm
Trim Finish	Graphite Grey
Materials	Top Frame, Lid, Handle & Base: ABS Top Support & Lid Infill: Galvanised Steel Plate Holder & Segregation Wall: Galvanised Steel Closure Spring: Spring Steel
Accessory Plates	179mm x 89mm
Plug Height	43mm Max.
Removeable Cover	Yes (Spring Retaining Arms)
Ingress Protection	IP20
Available Knockouts	Side: 8 x 22mm, Base: 6 x 27mm (To Accept Flexible Conduit)

Standards IEC 60670-23: 2006+A1:2016

Additional Information

Ensure that the mains supply is isolated before commencing installation and refer to the circuit diagram with the relevant product.
Bare earth cables must always be covered with appropriate sleeving and wired to the earth terminal.

FLOOR BOXES

Technical Specification



Product Code: FB2C

Description: 2 Compartment ABS Cavity Floor Box With Adjustable Depth

Compatible Plates

Finish Graphite Grey
Insert Colour White

Suitable For 2 x Accessory Plates
Dimensions: 179mm (W) x 89mm (H)

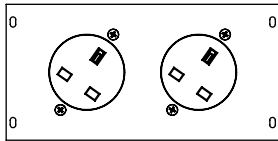

FBI010
UK x2 13A CIRCULAR SOCKET

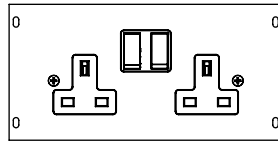

FBI036/ FBIST036
UK 2G 13A SWITCHED SOCKET
(DOUBLE POLE)

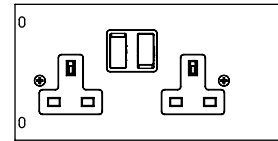

FBIL036/ FBILST036
UK 2G 13A SWITCHED SOCKET
-LEFT HANDED (DOUBLE POLE)

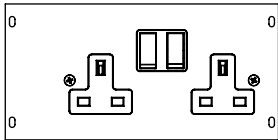

FBIR036/ FBIRST036
UK 2G 13A SWITCHED SOCKET
-RIGHT HANDED (DOUBLE POLE)

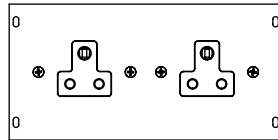

FBI038
X2 5A UNSWITCHED
ROUND PIN SOCKET

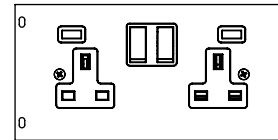

FBI780
UK 2G SWITCHED SOCKET
WITH USB



FAP061
BLANKING PLATE

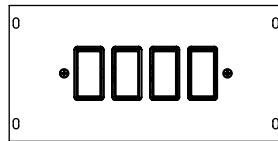

FBI20404
GRID PRO SWITCH PLATE x4

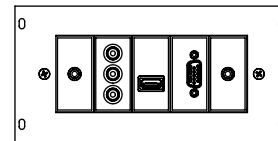

FBI316
NEW MEDIA PLATE x5