



## Driver LC 35W 200-350mA flexCC Ip SNC3

essence series

### Product description

- Constant current built-in LED driver
- For luminaires of protection class I and protection class II
- Temperature protection as per EN 61347-2-13 C5e
- Selectable fixed output current 350, 300, 250 and 200 mA
- Max. output power 36.5 W
- Up to 92 % efficiency
- Nominal life-time up to 50,000 h
- 5-year guarantee (conditions at [www.tridonic.com](http://www.tridonic.com))

### Housing properties

- Casing: metal, white
- Type of protection IP20

### Functions

- Overload protection
- Short-circuit protection
- No-load protection



**Standards**, page 3

**Wiring diagrams and installation examples**, page 3

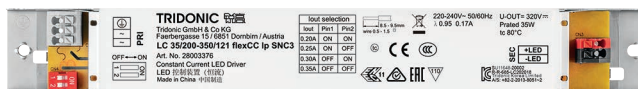

IP20          RoHS

### Driver LC 35W 200-350mA flexCC Ip SNC3

essence series

#### Technical data

|   |                  |
|---|------------------|
| Rated supply voltage  | 220 – 240 V      |
| AC voltage range  | 198 – 264 V      |
| Input current (at 230 V, 50 Hz, full load)                  | 0.17 A           |
| Leakage current (at 230 V, 50 Hz, full load)                | < 450 µA         |
| Mains frequency   | 50 / 60 Hz       |
| Overvoltage protection                                      | 320 V AC, 1 h    |
| Output power range  | 10.4 – 36.5 W    |
| Typ. efficiency (at 230 V / 50 Hz / full load) <sup>①</sup> | 92 %             |
| λ (at 230 V, 50 Hz, full load) <sup>①</sup>                 | 0.95             |
| Output current tolerance <sup>②</sup>                       | ± 7.5 %          |
| Max. output voltage   | 320 V            |
| THD (at 230 V, 50 Hz, full load) <sup>③</sup>               | < 20 %           |
| Max. peak output current at full load <sup>③</sup>          | 489 mA           |
| Output LF current ripple (< 120 Hz) at full load            | ± 30 %           |
| Starting time (at 230 V, 50 Hz, full load)                  | ≤ 0.5 s          |
| Turn off time (at 230 V, 50 Hz, full load)                  | ≤ 0.5 s          |
| Hold on time at power failure (output)                      | 20 s             |
| Ambient temperature ta (at life-time 50,000 h)              | 60 °C            |
| Storage temperature ts                                      | -40 ... +80 °C   |
| Mains burst capability                                      | 1 kV             |
| Mains surge capability (between L – N)                      | 1 kV             |
| Mains surge capability (between L/N – PE)                   | 2 kV             |
| Surge voltage at output side (against PE)                   | 3 kV             |
| Life-time   | up to 50,000 h   |
| Guarantee (conditions at www.tridonic.com)                  | 5 years          |
| Dimensions L x W x H  | 230 x 30 x 21 mm |
| Hole spacing D  | 218 mm           |

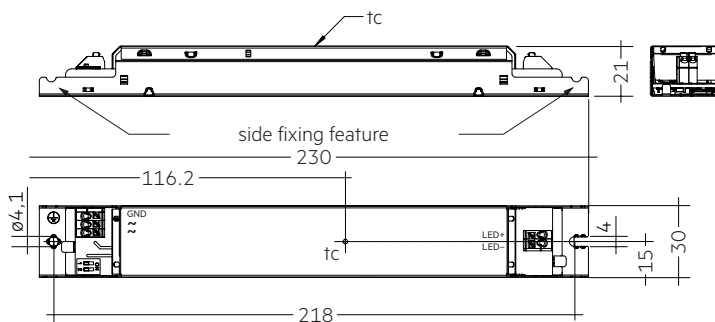

#### Ordering data

| Type                             | Article number | Packaging, carton | Packaging, pallet | Weight per pc. |
|----------------------------------|----------------|-------------------|-------------------|----------------|
| LC 35/200-350/121 flexCC Ip SNC3 | 28003376       | 50 pc(s).         | 4,200 pc(s).      | 0.14 kg        |

#### Specific technical data

| Type                             | Output current <sup>②</sup> | Min. forward voltage | Max. forward voltage | Max. output power | Typ. power consumption (at 230 V, 50 Hz, full load) | Typ. current consumption (at 230 V, 50 Hz, full load) | Max. casing temperature tc | Ambient temperature ta max. | load select   |
|----------------------------------|-----------------------------|----------------------|----------------------|-------------------|---|---|----------------------------|-----------------------------|---------------|
| LC 35/200-350/121 flexCC Ip SNC3 | 200 mA                      | 52 V                 | 121 V                | 24.2 W            | 25.9 W  | 120 mA  | 80 °C                      | -20 ... +60 °C              | 1=on / 2=on   |
|                                  | 250 mA                      | 52 V                 | 121 V                | 30.3 W            | 32.5 W  | 150 mA  | 80 °C                      | -20 ... +60 °C              | 1=on / 2=off  |
|                                  | 300 mA                      | 52 V                 | 121 V                | 36.3 W            | 38.1 W  | 170 mA  | 80 °C                      | -20 ... +60 °C              | 1=off / 2=on  |
|                                  | 350 mA                      | 52 V                 | 104 V                | 36.4 W            | 38.8 W  | 170 mA  | 80 °C                      | -20 ... +60 °C              | 1=off / 2=off |

<sup>①</sup> Test result at 350 mA.

<sup>②</sup> Output current is mean value.

<sup>③</sup> Test result at 25 °C.

## 1. Standards

EN 55015  
EN 61000-3-2  
EN 61000-3-3  
EN 61347-1  
EN 61347-2-13  
EN 61547  
EN 62384

## 2. Thermal details and life-time

### 2.1 Expected life-time

| Expected life-time       |           |           |           |          |          |
|--------------------------|-----------|-----------|-----------|----------|----------|
| Type                     | ta        | 40 °C     | 50 °C     | 60 °C    | 70 °C    |
| <b>LC 35/200-350/121</b> | tc        | 50 °C     | 60 °C     | 70 °C    | 80 °C    |
| <b>flexCC Ip SNC3</b>    | Life-time | >50,000 h | >50,000 h | 50,000 h | 30,000 h |

The LED driver is designed for a life-time stated above under reference conditions and with a failure probability of less than 10 %.

The relation of tc to ta temperature depends also on the luminaire design. If the measured tc temperature is approx. 5 K below tc max., ta temperature should be checked and eventually critical components (e.g. ELCAP) measured. Detailed information on request.

## 3. Installation / wiring

### 3.1 Circuit diagram

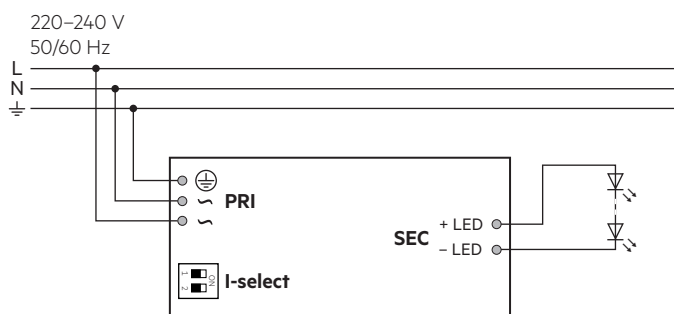

### 3.2 Wiring type and cross section

For wiring use stranded wire with ferrules or solid wire from 0.5 – 1.5 mm<sup>2</sup>. Strip 8.5 – 9.5 mm of insulation from the cables to ensure perfect operation of the push-wire terminals (WAGO 250).

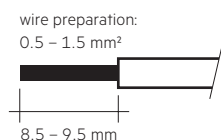

### 3.3 Release of the wiring

Press down the “push button” and remove the cable from front.

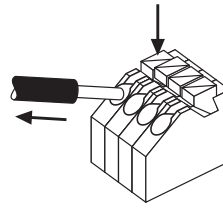

### 3.4 Wiring guidelines

- All connections must be kept as short as possible to ensure good EMI behaviour.
- Mains leads should be kept apart from LED driver and other leads (ideally 5 – 10 cm distance)
- Max. length of output wires is 2 m.
- Incorrect wiring can damage LED modules.
- To avoid the damage of the Driver, the wiring must be protected against short circuits to earth (sharp edged metal parts, metal cable clips, louver, etc.).

### 3.5 Earth connection

The earth connection is conducted as protection earth (PE). The LED driver can be earthed via metal housing. If the LED driver will be earthed, protection earth (PE) has to be used. There is no earth connection required for the functionality of the LED driver. Earth connection is recommended to improve following behaviour.

- Electromagnetic interferences (EMI)
- Transmission of mains transients to the LED output

In general it is recommended to earth the LED driver if the LED module is mounted on earthed luminaire parts respectively heat sinks and thereby representing a high capacity against earth.

For Class II application, protection earth is no need to be connected, below 2 scenarios should be considered:

- If the LED driver housing is screw on a metal part inside the luminaires, both LED driver and LED module must be insulated.
- If the LED driver housing is screw on a plastic part inside the luminaires, the LED module need to be insulated.

### 3.6 Replace LED module

1. Mains off
2. Remove LED module
3. Wait for 30 seconds
4. Connect LED module again

Hot plug-in or output switching of LEDs is not permitted and may cause a very high current to the LEDs.

### 3.7 Mounting of device

Max. torque for fixing: 0.5 Nm/M4

3.8 Current setting

200 mA: Switch 1 = On, Switch 2 = On

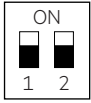

250 mA: Switch 1 = On, Switch 2 = Off

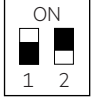

300 mA: Switch 1 = Off, Switch 2 = On



350 mA: Switch 1 = Off, Switch 2 = Off

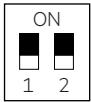

**!** Set the current by DIP switch after mains off. Use of DIP switch only after mains off.

4. Electrical values

4.1 Efficiency vs load

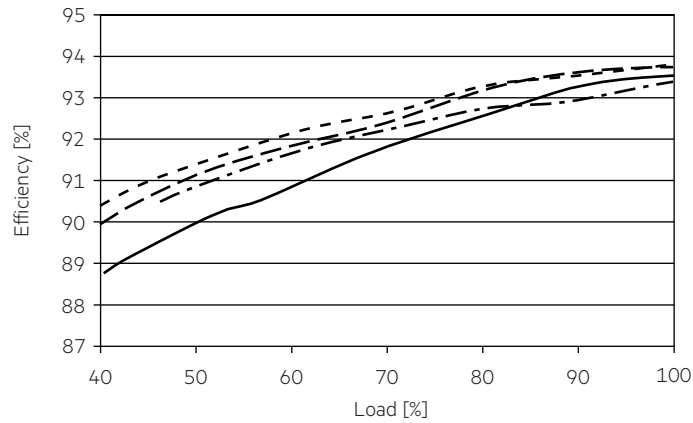

4.2 Power factor vs load

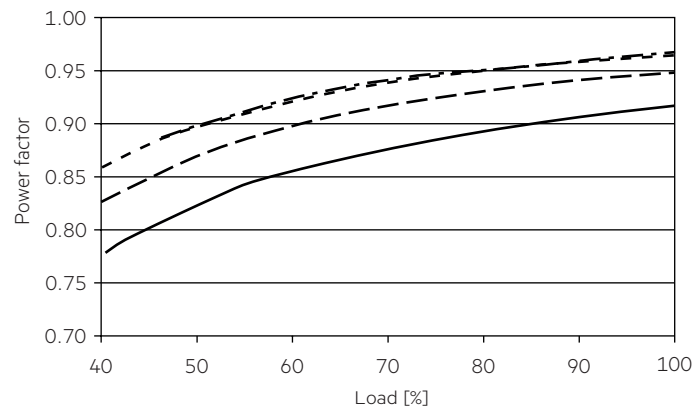

4.3 Input power vs load

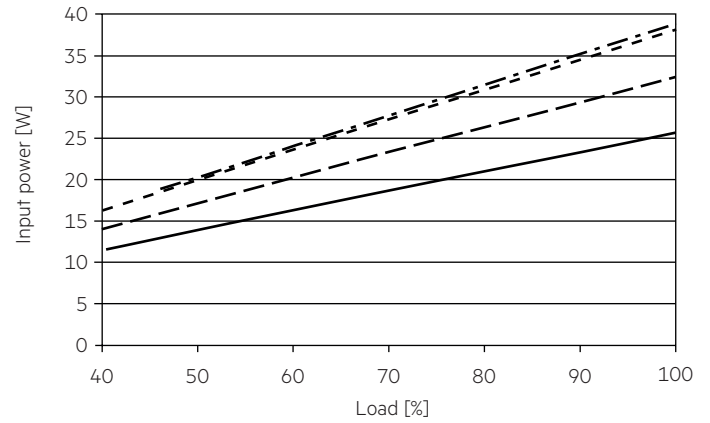

4.4 Input current vs load

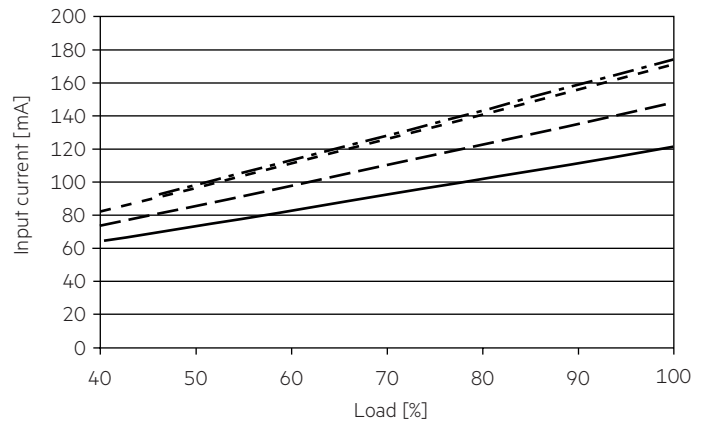

4.5 THD vs load (without harmonic < 5 mA or 0.6 % of the input current)

THD without harmonic < 5 mA (0.6 %) of the input current:

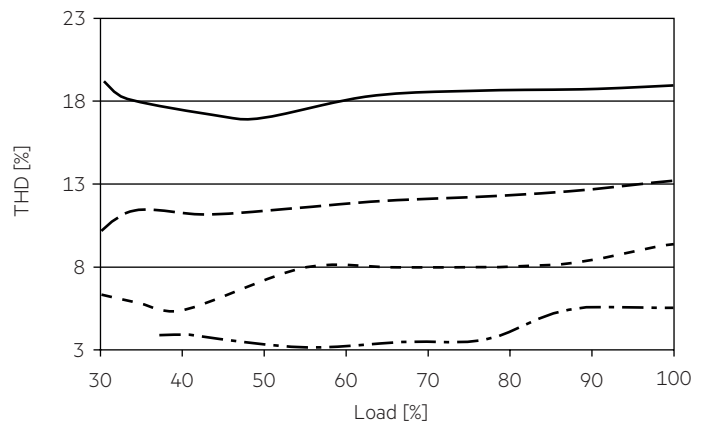

- 200 mA
- - - 250 mA
- · - · 300 mA
- - - - 350 mA

#### 4.6 Maximum loading of automatic circuit breakers in relation to inrush current

| Automatic circuit breaker type          | C10                 | C13                 | C16                 | C20                 | B10                 | B13                 | B16                 | B20                 | Inrush current   |       |
|---|---------------------|---------------------|---------------------|---------------------|---------------------|---------------------|---------------------|---------------------|------------------|-------|
| Installation Ø                          | 1.5 mm <sup>2</sup> | 1.5 mm <sup>2</sup> | 1.5 mm <sup>2</sup> | 2.5 mm <sup>2</sup> | 1.5 mm <sup>2</sup> | 1.5 mm <sup>2</sup> | 1.5 mm <sup>2</sup> | 2.5 mm <sup>2</sup> | I <sub>max</sub> | Time  |
| <b>LC 35/200-350/121 flexCC Ip SNC3</b> | 41                  | 53                  | 65                  | 82                  | 41                  | 53                  | 65                  | 82                  | 71 A             | 20 µs |

These are max. values calculated out of continuous current running the device on full load. There is no limitation due to in-rush current. If load is smaller than full load for calculation only continuous current has to be considered.

#### 4.7 Harmonic distortion in the mains supply (at 230 V / 50 Hz and full load) in %

|   | THD  | 3.   | 5.   | 7.  | 9.  | 11. |
|---|------|------|------|-----|-----|-----|
| <b>LC 35/200-350/121 flexCC Ip SNC3</b> | < 15 | < 10 | < 10 | < 7 | < 5 | < 3 |

Acc. to 6100-3-2. Harmonics < 5 mA or < 0.6 % (whatever is greater) of the input current are not considered for calculation of THD.

## 5. Functions

### 5.1 Short-circuit behaviour

In case of a short circuit on the output side (LED) the LED driver switches into hic-cup mode. After elimination of the short-circuit fault the LED driver will recover automatically.

### 5.2 No-load operation

The LED driver works in burst working mode to provide a constant output voltage regulation which allows the application to be able to work safely when LED string opens due to a failure.

### 5.3 Overload protection

If the maximum load is exceeded by a defined internal limit, the LED driver will protect itself and LED may flicker. After elimination of the overload, the nominal operation is restored automatically.

## 6. Miscellaneous

### 6.1 Insulation and electric strength testing of luminaires

Electronic devices can be damaged by high voltage. This has to be considered during the routine testing of the luminaires in production.

According to IEC 60598-1 Annex Q (informative only!) or ENEC 303-Annex A, each luminaire should be submitted to an insulation test with 500 V<sub>DC</sub> for 1 second. This test voltage should be connected between the interconnected phase and neutral terminals and the earth terminal.

The insulation resistance must be at least 2 MΩ.

As an alternative, IEC 60598-1 Annex Q describes a test of the electrical strength with 1500 V<sub>AC</sub> (or 1.414 x 1500 V<sub>DC</sub>). To avoid damage to the electronic devices this test must not be conducted.

### 6.2 Conditions of use and storage

Humidity: 5 % up to max. 85 %, not condensed (max. 56 days/year at 85 %)

Storage temperature: -40 °C up to max. +80 °C

The devices have to be within the specified temperature range (ta) before they can be operated.

The LED driver is declared as inbuilt LED controlgear, meaning it is intended to be used within a luminaire enclosure.

If the product is used outside a luminaire, the installation must provide suitable protection for people and environment (e.g. in illuminated ceilings).

### 6.3 Maximum number of switching cycles

All LED driver are tested with 50,000 switching cycles.

### 6.4 Additional information

Additional technical information at [www.tridonic.com](http://www.tridonic.com) → Technical Data

Lifetime declarations are informative and represent no warranty claim. No warranty if device was opened.