



### Driver LCA 10W 150–400mA one4all SC PRE

premium series

#### Product description

- NEW: lumDATA (DALI-2 part ext. 251, 252 and 253)
- Dimmable built-in constant current LED Driver
- Can be either used build-in or independent with clip-on strain-relief (see accessory)
- Dimming range 1 – 100 %
- For luminaires of protection class I and protection class II
- Adjustable output current between 150 and 400 mA
- Max. output power 10 W
- Up to 82 % efficiency
- Power input on stand-by < 0.2 W
- Nominal lifetime up to 100,000 h
- 5 years guarantee (conditions at [www.tridonic.com](http://www.tridonic.com))

#### Housing properties

- Casing: polycarbonate, white
- Type of protection IP20

#### Interfaces

- one4all (DALI-2 DT 6, DSI, switchDIM, corridorFUNCTION)
- ready2mains™ (configuration and dimming via mains)
- Terminal blocks: 45° push terminals

#### Functions

- Adjustable output current in 1-mA-steps (DALI, ready2mains™, I-SELECT 2)
- Fulfills DALI-2 parts: 251 (Luminaire data), 252 (Energy reporting) and 253 (Diagnostics & Maintenance)
- Constant light output function (CLO)
- Power-up fading at AC
- Configurable via ready2mains™
- Switch off the Driver with fade2zero
- Service monitor to log certain events
- Protective features (overtemperature, short-circuit, overload, no-load, input voltage range, reduced surge amplification)
- Suitable for emergency escape lighting systems acc. to EN 50172

#### Benefits

- Application-oriented operating window for maximum compatibility
- Best energy savings due to low standby losses and high efficiency
- Flexible configuration via DALI, ready2mains™ and I-SELECT 2

#### Typical applications

- For linear/area lighting in office applications

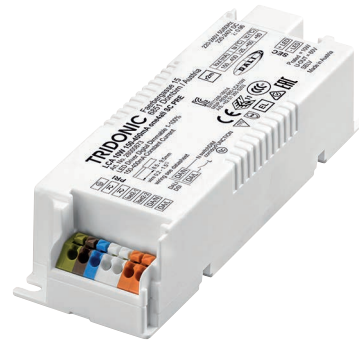

With strain-relief



Standards, page 5



### Driver LCA 10W 150–400mA one4all SC PRE premium series

#### Technical data

|  |                         |
|--|-------------------------|
| Rated supply voltage   | 220 – 240 V             |
| Input voltage, AC  | 198 – 264 V             |
| Input voltage, DC  | 176 – 280 V             |
| Mains frequency  | 0 / 50 / 60 Hz          |
| Overvoltage protection   | 320 V AC, 48 h          |
| Typ. current (at 230 V, 50 Hz, full load) <sup>①</sup> ⊕                 | 35 – 60 mA              |
| Typ. current (220 V, 0 Hz, full load, 15 % dimming level) <sup>②</sup> ⊕ | 10 – 20 mA              |
| Leakage current (at 230 V, 50 Hz, full load) <sup>③</sup> ⊕              | < 700 µA                |
| Max. input power   | 13 W                    |
| Typ. efficiency (at 230 V / 50 Hz / full load) <sup>④</sup> ⊕            | 82 %                    |
| λ (at 230 V, 50 Hz, full load) <sup>⑤</sup> ⊕                            | 0.96                    |
| Typ. power consumption on stand-by <sup>⑥</sup> ⊕                        | < 0.2 W                 |
| Typ. input current in no-load operation                                  | 12.5 mA                 |
| Typ. input power in no-load operation                                    | 0.36 W                  |
| In-rush current (peak / duration)  | 16 A / 255 µs           |
| THD (at 230 V, 50 Hz, full load) <sup>⑦</sup> ⊕                          | < 8 %                   |
| Starting time (at 230 V, 50 Hz, full load) <sup>⑧</sup> ⊕                | < 0.7 s                 |
| Starting time (DC mode)  | < 0.4 s                 |
| Switchover time (AC/DC) <sup>⑨</sup> ⊕                                   | < 0.4 s                 |
| Turn off time (at 230 V, 50 Hz, full load)                               | < 20 ms                 |
| Output current tolerance <sup>⑩</sup> ⊕                                  | ± 3 %                   |
| Max. output current peak (non-repetitive)                                | ≤ output current + 40 % |
| Output LF current ripple (< 120 Hz)                                      | ± 5 %                   |
| Output P <sub>ST</sub> <sup>LM</sup> (at full load)                      | ≤ 1                     |
| Output SVM (at full load)  | ≤ 0.4                   |
| Max. output voltage (no-load voltage)                                    | 60 V                    |
| Dimming range  | 1 – 100 %               |
| Mains surge capability (between L – N)                                   | 1 kV                    |
| Mains surge capability (between L/N – PE)                                | 2 kV                    |
| Surge voltage at output side (against PE)                                | < 500 V                 |
| Type of protection   | IP20                    |
| Lifetime   | up to 100,000 h         |
| Guarantee (conditions at www.tridonic.com)                               | 5 years                 |
| Dimensions L x W x H   | 130 x 43 x 30 mm        |

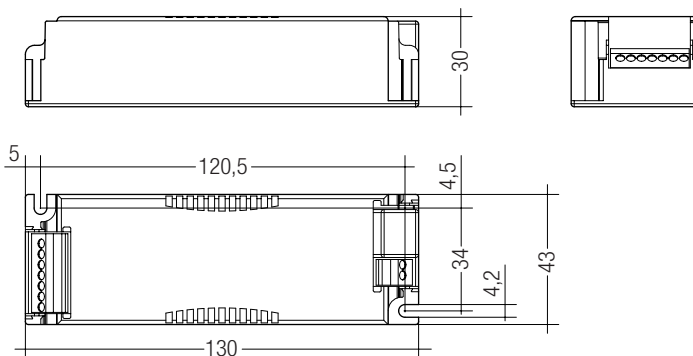

#### Ordering data

| Type                             | Article number | Packaging carton | Packaging pallet | Weight per pc. |
|----------------------------------|----------------|------------------|------------------|----------------|
| LCA 10W 150-400mA one4all SC PRE | 28000673       | 10 pc(s).        | 1,000 pc(s).     | 0.125 kg       |

#### Specific technical data

| Type                             | Output current <sup>①</sup> ⊕ | Min. forward voltage | Max. forward voltage | Max. output power | Typ. power consumption (at 230 V, 50 Hz, full load) | Typ. current consumption (at 230 V, 50 Hz, full load) | Max. casing temperature t <sub>c</sub> | Ambient temperature t <sub>a</sub> | I-SELECT 2 resistor value <sup>②</sup> |
|----------------------------------|-------------------------------|----------------------|----------------------|-------------------|---|---|--|------------------------------------|--|
| LCA 10W 150-400mA one4all SC PRE | 150 mA                        | 15 V                 | 40 V                 | 6 W               | 8.1 W   | 37 mA   | 80 °C                                  | -25 ... +65 °C                     | open                                   |
|                                  | 200 mA                        | 15 V                 | 40 V                 | 8 W               | 10.2 W  | 46 mA   | 80 °C                                  | -25 ... +65 °C                     | 25.00 kΩ                               |
|                                  | 250 mA                        | 15 V                 | 40 V                 | 10 W              | 12.2 W  | 54 mA   | 80 °C                                  | -25 ... +65 °C                     | 20.00 kΩ                               |
|                                  | 300 mA                        | 15 V                 | 33 V                 | 10 W              | 12.1 W  | 54 mA   | 80 °C                                  | -25 ... +65 °C                     | 16.67 kΩ                               |
|                                  | 350 mA                        | 15 V                 | 29 V                 | 10 W              | 11.9 W  | 53 mA   | 80 °C                                  | -25 ... +65 °C                     | 14.29 kΩ                               |
|                                  | 400 mA                        | 15 V                 | 25 V                 | 10 W              | 12.0 W  | 53 mA   | 80 °C                                  | -25 ... +65 °C                     | short circuit (0 Ω)                    |

① Valid at 100 % dimming level.

② Depending on the selected output current.

③ Depending on the DALI traffic at the interface.

④ The table only lists a number of possible operating points but does not cover each single point. The output current can be set within the total value range in 1-mA-steps.

⑤ Not compatible with I-SELECT (generation 1). Calculated resistor value.

⑥ Output current is mean value.

⑦ Valid for immediate change of power supply type otherwise the starting time is valid.



**Strain-relief set 43x30mm**

**Product description**

- Optional strain-relief set for independent applications
- Transforms the LED Driver into a fully class II compatible LED Driver (e.g. ceiling installation)
- Easy and tool-free mounting to the LED Driver, screwless cable-clamp channels for long strain-relief (30 x 43 x 30 mm)
- With screws for short strain-relief (15 x 34 x 30 mm)
- Overall length = length L (LED Driver) + 2 x 30 mm (long strain-relief set), 2 x 15 mm (short strain-relief) or long and short strain-relief any combination
- Standard SC (L = 30 mm) available as non-pre-assembled and pre-assembled
- Short SC (L = 15 mm) only pre-assembled available



ACU SC 30x43x30mm CLIP-ON SR SET      ACU SC 30x43x30mm CLIP-ON SR SET 300  
(28001168, non-pre-assembled)      (28001351, non-pre-assembled, 300 pcs. packaging)



ACU SC 30x43x30mm CLIP-ON SR PA  
(28001699, pre-assembled)

ACU SC 15x43x30mm CLIP-ON SR PA  
(28001574, pre-assembled)

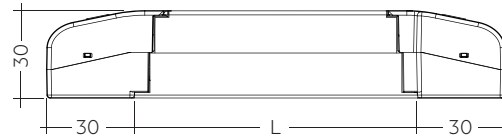

Permissible  
cable jacket  
diameter:  
2.2 – 9 mm

ACU SC 30x43x30mm CLIP-ON SR SET / PA

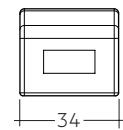
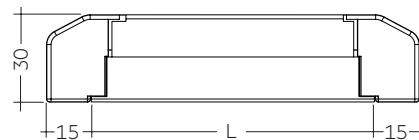

Permissible  
cable jacket  
diameter:  
3 – 9 mm

ACU SC 15x43x30mm CLIP-ON SR PA

**Ordering data**

| Type                                     | Article number  | Packaging carton <sup>①</sup> | Packaging outer box | Weight per pc. |
|--|-----------------|-------------------------------|---------------------|----------------|
| <b>ACU SC 43x30mm CLIP-ON SR SET</b>     | <b>28001168</b> | 10 pc(s).                     | 500 pc(s).          | 0.038 kg       |
| <b>ACU SC 43x30mm CLIP-ON SR SET 300</b> | <b>28001351</b> | 300 pc(s).                    | 300 pc(s).          | 0.038 kg       |
| <b>ACU SC 30x43x30mm CLIP-ON SR PA</b>   | <b>28001699</b> | 10 pc(s).                     | 500 pc(s).          | 0.021 kg       |
| <b>ACU SC 15x43x30mm CLIP-ON SR PA</b>   | <b>28001574</b> | 10 pc(s).                     | 1,200 pc(s).        | 0.010 kg       |

<sup>①</sup> 28001168: A carton of 10 pcs. is equal to 10 sets, each with 2 strain-reliefs parts.

28001351: A carton of 300 pcs. is equal to 300 sets, each with 2 strain-reliefs parts.

28001699 + 28001574: A carton contains exactly 10 pcs. strain-reliefs (no sets).

### Product description

- Ready-for-use resistor to set output current value
- Compatible with LED Driver featuring I-SELECT 2 interface; not compatible with I-SELECT (generation 1)
- Resistor is base insulated
- Resistor power 0.25 W
- Current tolerance  $\pm 2\%$  to nominal current value
- Compatible with LED Driver series PRE and EXC

### Example of calculation

- $R [k\Omega] = 5 V / I_{out} [mA] \times 1000$
- E96 resistor value used
- Resistor value tolerance  $\leq 1\%$ ; resistor power  $\geq 0.1 W$ ; base insulation necessary
- When using a resistor value beyond the specified range, the output current will automatically be set to the minimum value (resistor value too big), respectively to the maximum value (resistor value too small)

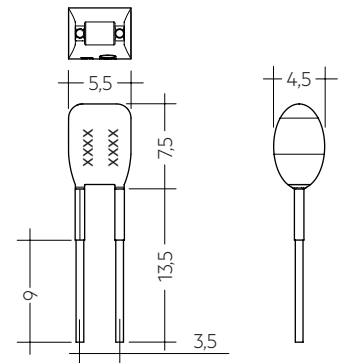

### Ordering data

| Type                     | Article number | Colour | Marking | Current | Resistor value   | Packaging bag | Weight per pc. |
|--------------------------|----------------|--------|---------|---------|------------------|---------------|----------------|
| I-SELECT 2 PLUG 150MA BL | 28001102       | Blue   | 0150 mA | 150 mA  | 33.20 k $\Omega$ | 10 pc(s).     | 0.001 kg       |
| I-SELECT 2 PLUG 175MA BL | 28001103       | Blue   | 0175 mA | 175 mA  | 28.70 k $\Omega$ | 10 pc(s).     | 0.001 kg       |
| I-SELECT 2 PLUG 200MA BL | 28001104       | Blue   | 0200 mA | 200 mA  | 24.90 k $\Omega$ | 10 pc(s).     | 0.001 kg       |
| I-SELECT 2 PLUG 225MA BL | 28001105       | Blue   | 0225 mA | 225 mA  | 22.10 k $\Omega$ | 10 pc(s).     | 0.001 kg       |
| I-SELECT 2 PLUG 250MA BL | 28001106       | Blue   | 0250 mA | 250 mA  | 20.00 k $\Omega$ | 10 pc(s).     | 0.001 kg       |
| I-SELECT 2 PLUG 275MA BL | 28001107       | Blue   | 0275 mA | 275 mA  | 18.20 k $\Omega$ | 10 pc(s).     | 0.001 kg       |
| I-SELECT 2 PLUG 300MA BL | 28001108       | Blue   | 0300 mA | 300 mA  | 16.50 k $\Omega$ | 10 pc(s).     | 0.001 kg       |
| I-SELECT 2 PLUG 325MA BL | 28001109       | Blue   | 0325 mA | 325 mA  | 15.40 k $\Omega$ | 10 pc(s).     | 0.001 kg       |
| I-SELECT 2 PLUG 350MA BL | 28001110       | Blue   | 0350 mA | 350 mA  | 14.30 k $\Omega$ | 10 pc(s).     | 0.001 kg       |
| I-SELECT 2 PLUG 375MA BL | 28001111       | Blue   | 0375 mA | 375 mA  | 13.30 k $\Omega$ | 10 pc(s).     | 0.001 kg       |
| I-SELECT 2 PLUG 400MA BL | 28001112       | Blue   | 0400 mA | 400 mA  | 12.40 k $\Omega$ | 10 pc(s).     | 0.001 kg       |
| I-SELECT 2 PLUG MAX BL   | 28001099       | Blue   | MAX     | MAX     | 0.00 k $\Omega$  | 10 pc(s).     | 0.001 kg       |

## 1. Standards

EN 55015  
 EN 61000-3-2  
 EN 61000-3-3  
 EN 61347-1  
 EN 61347-2-13  
 EN 62384  
 EN 61547  
 EN 62386-101 (DALI-2)  
 EN 62386-102 (DALI-2)  
 EN 62386-207 (DALI-2, inkl. Teil 251, 252, 253)  
 According to EN 50172 for use in central battery systems  
 According to EN 60598-2-22 suitable for emergency lighting installations

Housing fulfils requirements for reinforced insulation according EN 60598-1.

### 1.1 Glow wire test

according to EN 61347-1 with increased temperature of 850 °C passed.

## 2. Thermal details and lifetime

### 2.1 Expected lifetime

| Expected lifetime                |                |          |             |             |             |          |          |
|----------------------------------|----------------|----------|-------------|-------------|-------------|----------|----------|
| Type                             | Output current | ta       | 40 °C       | 50 °C       | 55 °C       | 60 °C    | 65 °C    |
| LCA 10W 150-400mA one4all SC PRE | 150 – 400 mA   | tc       | 60 °C       | 65 °C       | 70 °C       | 75 °C    | 80 °C    |
|                                  |                | Lifetime | > 100,000 h | > 100,000 h | > 100,000 h | 80,000 h | 50,000 h |

The LED Driver is designed for a lifetime stated above under reference conditions and with a failure probability of less than 10 %.

The relation of tc to ta temperature depends also on the luminaire design.

If the measured tc temperature is approx. 5 K below tc max., ta temperature should be checked and eventually critical components (e.g. ELCAP) measured. Detailed information on request.

## 3. Installation / wiring

### 3.1 Circuit diagram

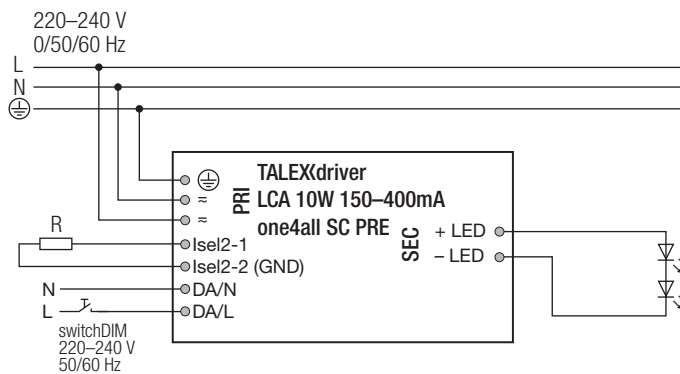
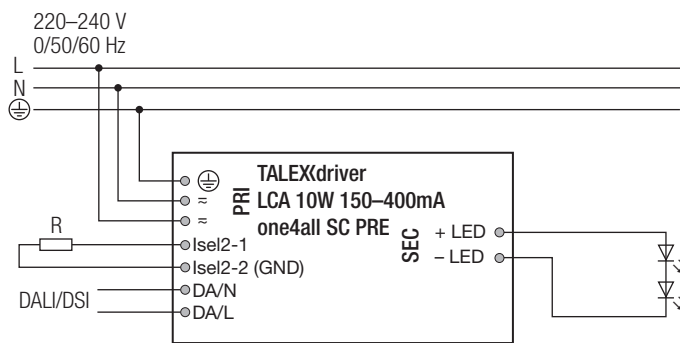

For wiring in dimming operation with ready2mains refer to the ready2mains Gateway data sheet.

### 3.2 Wiring type and cross section

The wiring can be in stranded wires with ferrules or solid with a cross section of 0.2–1.5 mm<sup>2</sup>.

Strip 8.5–9.5 mm of insulation from the cables to ensure perfect operation of the push-wire terminals.

Use one wire for each terminal connector only.

Use each strain relief channel for one cable only.

LED module/LED Driver/supply

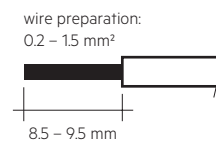

### 3.3 Loose wiring

Press down the “push button” and remove the cable from front.

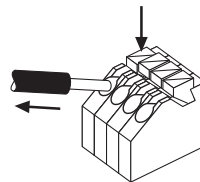

### 3.4 Fixing conditions when using as independent Driver with Clip-On

Dry, acidfree, oilfree, fatfree. It is not allowed to exceed the maximum ambient temperature ( $t_a$ ) stated on the device. Minimum distances stated below are recommendations and depend on the actual luminaire. Is not suitable for fixing in corner.

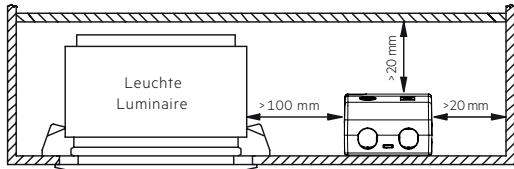

### 3.5 Wiring guidelines

- Run the secondary lines separately from the mains connections and lines to achieve good EMC performance.
- The max. secondary cable (LED module) length is 2 m (4 m circuit).
- For good EMC performance, keep the LED wiring as short as possible.
- To comply with the EMC regulations run the secondary wires (LED module) in parallel.
- Secondary switching is not permitted.
- The LED Driver has no inverse-polarity protection on the secondary side. Wrong polarity can damage LED modules with no inverse-polarity protection.
- Wrong wiring of the LED Driver can lead to malfunction or irreparable damage.
- To avoid the damage of the Driver, the wiring must be protected against short circuits to earth (sharp edged metal parts, metal cable clips, louver, etc.).

### 3.6 Hot plug-in

Hot plug-in is not supported due to residual output voltage of  $> 0$  V. If a LED load is connected the device has to be restarted before the output will be activated again. This can be done via mains reset or via interface (DALI, DSI, switchDIM, ready2mains).

### 3.7 Earth connection

The earth connection is conducted as protection earth (PE). The LED Driver can be earthed via earth terminal. If the LED Driver will be earthed, protection earth (PE) has to be used. There is no earth connection required for the functionality of the LED Driver. Earth connection is recommended to improve following behaviour:

- Electromagnetic interferences (EMI)
- LED glowing at standby
- Transmission of mains transients to the LED output

In general it is recommended to earth the LED Driver if the LED module is mounted on earthed luminaire parts respectively heat sinks and thereby representing a high capacity against earth.

### 3.8 I-SELECT 2 resistors connected via cable

For details see:  
[http://www.tridonic.com/com/en/download/technical/LCA\\_PRE\\_LC\\_EXC\\_ProductManual\\_en.pdf](http://www.tridonic.com/com/en/download/technical/LCA_PRE_LC_EXC_ProductManual_en.pdf).

### 3.9 Installation note

Max. torque at the clamping screw: 0.5 Nm / M4

## 4. Electrical values

### 4.1 Operating window

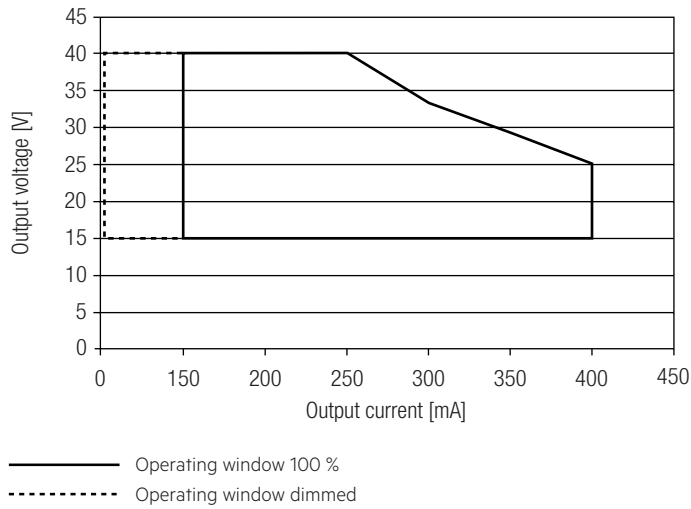

Make sure that the LED Driver is operated within the given window under all operating conditions. Special attention needs to be paid at dimming and DC emergency operation as the forward voltage of the connected LED modules varies with the dimming level, due to the implemented amplitude dimming technology. Coming below the specified minimum output voltage of the LED Driver may cause the device to shut-down. See chapter "6.11 Light level in DC operation" for more information.

### 4.4 THD vs load (without harmonic < 5 mA or 0.6 % of the input current)

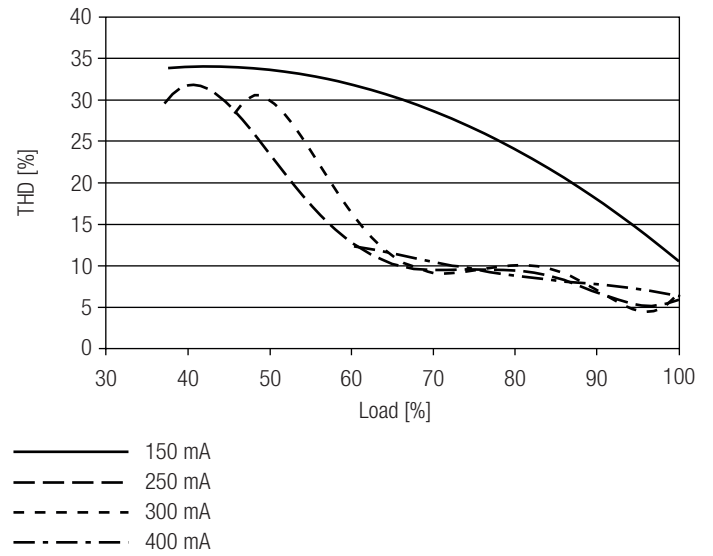

100 % load corresponds to the max. output power (full load) according to the table on page 2.

### 4.2 Efficiency vs load

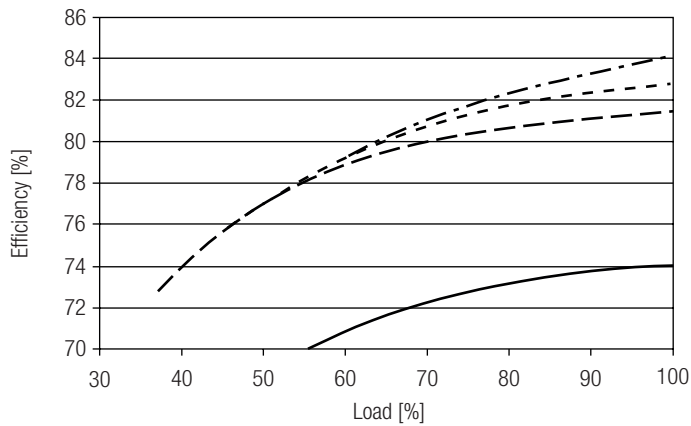

### 4.3 Power factor vs load

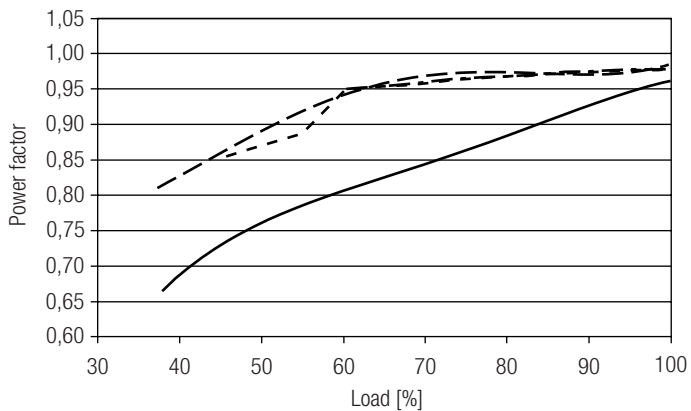

#### 4.5 Maximum loading of automatic circuit breakers in relation to inrush current

| Automatic circuit breaker type          | C10                 | C13                 | C16                 | C20               | B10                 | B13                 | B16                 | B20               | Inrush current |        |
|---|---------------------|---------------------|---------------------|-------------------|---------------------|---------------------|---------------------|-------------------|----------------|--------|
| Installation Ø                          | 1.5 mm <sup>2</sup> | 1.5 mm <sup>2</sup> | 2.5 mm <sup>2</sup> | 4 mm <sup>2</sup> | 1.5 mm <sup>2</sup> | 1.5 mm <sup>2</sup> | 2.5 mm <sup>2</sup> | 4 mm <sup>2</sup> | $I_{max}$      | time   |
| <b>LCA 10W 150-400mA one4all SC PRE</b> | 40                  | 56                  | 64                  | 80                | 24                  | 31                  | 38                  | 48                | 16 A           | 255 µs |

These are max. values calculated out of inrush current! Please consider not to exceed the maximum rated continuous current of the circuit breaker. Calculation uses typical values from ABB series S200 as a reference. Actual values may differ due to used circuit breaker types and installation environment.

#### 4.6 Harmonic distortion in the mains supply (at 230 V / 50 Hz and full load) in %

|   | THD | 3.  | 5.  | 7.  | 9.  | 11. |
|---|-----|-----|-----|-----|-----|-----|
| <b>LCA 10W 150-400mA one4all SC PRE</b> | < 8 | < 4 | < 2 | < 3 | < 1 | < 1 |

Acc. to 61000-3-2. Harmonics < 5 mA or < 0.6 % (whatever is greater) of the input current are not considered for calculation of THD.

#### 4.7 Dimming

Dimming range 1% to 100 %

Digital control with:

- DSI signal: 8 bit Manchester Code  
Speed 1% to 100 % in 1.4 s
- DALI signal: 16 bit Manchester Code  
Speed 1% to 100 % in 0.2 s  
Programmable parameter:  
Minimum dimming level  
Maximum dimming level  
Default minimum = 1 %  
Programmable range  $1\% \leq \text{MIN} \leq 100\%$   
Default maximum = 100 %  
Programmable range  $100\% \geq \text{MAX} \geq 1\%$

Dimming curve is adapted to the eye sensitiveness. Dimming is realized by amplitude dimming.

#### 4.8 Dimming characteristics

Digital dimming value

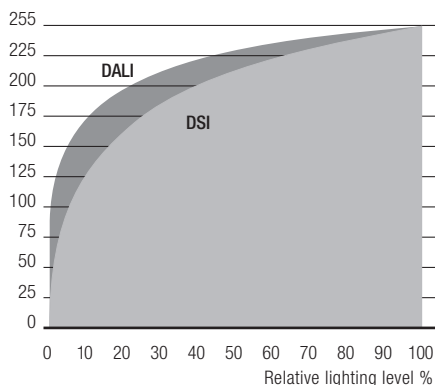

Dimming characteristics as seen by the human eye

### 5. Interfaces / communication

#### 5.1 Control input (DA/N, DA/L)

Digital DALI signal or switchDIM can be wired on the same terminals (DA/N and DA/L).

The control input is non-polar for digital control signals (DALI, DSI). The control signal is not SELV. Control cable has to be installed in accordance to the requirements of low voltage installations. Different functions depending on each module.

#### 5.2 Control input ready2mains (L, N)

The digital ready2mains protocol is modulated onto the mains signal which is wired to the mains terminal (L and N).

#### 5.3 switchDIM

Integrated switchDIM function allows a direct connection of a pushbutton for dimming and switching.

Brief push (< 0.6 s) switches LED Driver ON and OFF. The dimm level is saved at power-down and restored at power-up.

When the pushbutton is held, LED modules are dimmed. After repush the LED modules are dimmed in the opposite direction.

In installations with LED Drivers with different dimming levels or opposite dimming directions (e.g. after a system extension), all LED Drivers can be synchronized to 50 % dimming level by a 10 s push.

Use of pushbutton with indicator lamp is not permitted.

#### switchDIM 2

Version 2 has now the possibility to define different fade times used for short button press events. So the fade time to set memory level (if wake-up from standby) as well as the fade time to switch off can now be configured.

### 6. Functions

#### 6.1 Function: adjustable current

The output current of the LED Driver can be adjusted in a certain range. For adjustment there are three options available.

Option 1: DALI

Adjustment is done by masterCONFIGURATOR (see masterCONFIGURATOR documentation).

Option 2: I-SELECT 2

By inserting a suitable resistor into the I-SELECT 2 interface, the current value can be adjusted. The relationship between output current and resistor value can be found in the chapter "Accessories I-SELECT 2 Plugs".



Please note that the resistor values for I-SELECT 2 are not compatible with I-SELECT (generation 1). Installation of an incorrect resistor may cause irreparable damage to the LED module(s).

Resistors for the main output current values can be ordered from Tridonic (see accessories).

Option 3: ready2mains

Adjustment is done by the ready2mains programmer and the corresponding configuration software (see ready2mains documentation).

The priority for current adjustment methods is DALI (highest priority), I-SELECT 2, ready2mains (lowest priority).



## 6.2 ready2mains – configuration

The ready2mains interface can be used to configure the main parameters of LED Drivers via the mains wiring, such as LED output current, CLO and DC level. These parameters can be adjusted either via ready2mains-capable configuration software or directly via the ready2mains programmer (output current only).

## 6.3 ready2mains – dimming

ready2mains allows for mains-based group dimming, controlled via the ready2mains protocol and appropriate dimming interfaces.

For details on the operation of ready2mains and its components see the relevant technical information.

## 6.4 Short-circuit behaviour

In case of a short-circuit at the LED output the LED output is switched off. After restart of the LED Driver the output will be activated again. The restart can either be done via mains reset or via interface (DALI, DSI, switchDIM, ready2mains).

## 6.5 No-load operation

The LED Driver will not be damaged in no-load operation. The output will be deactivated and is therefore free of voltage. If a LED load is connected the device has to be restarted before the output will be activated again.

## 6.6 Overload protection

If the maximum load is exceeded by a defined internal limit, the LED Driver turns off the LED output. After restart of the LED Driver the output will be activated again. The restart can either be done via mains reset or via interface (DALI, DSI, switchDIM, ready2mains).

## 6.7 Overtemperature protection

The LED Driver is protected against temporary thermal overheating. If the temperature limit is exceeded the output current of the LED module(s) is reduced. The temperature protection is activated above  $t_{c\ max}$ . The activation temperature differs depending on the LED load. On DC operation this function is deactivated to fulfill emergency requirements.

## 6.8 corridorFUNCTION

The corridorFUNCTION can be programmed in two different ways. To program the corridorFUNCTION by means of software a DALI-USB interface is needed in combination with a DALI PS. The software can be the masterCONFIGURATOR. To activate the corridorFUNCTION without using software a voltage of 230 V has to be applied for five minutes at the switchDIM connection. The unit will then switch automatically to the corridorFUNCTION.

Note:

If the corridorFUNCTION is wrongly activated in a switchDIM system (for example a switch is used instead of pushbutton), there is the option of installing a pushbutton and deactivating the corridorFUNCTION mode by five short pushes of the button within three seconds.

switchDIM and corridorFUNCTION are very simple tools for controlling gears with conventional pushbuttons or motion sensors.

To ensure correct operation a sinusoidal mains voltage with a frequency of 50 Hz or 60 Hz is required at the control input.

Special attention must be paid to achieving clear zero crossings. Serious mains faults may impair the operation of switchDIM and corridorFUNCTION.

## 6.9 Constant light output (CLO)

The luminous flux of a LED decreases constantly over the lifetime. The CLO function ensures that the emitted luminous flux remains stable. For that purpose the LED current will increase continuously over the LED lifetime. In masterCONFIGURATOR it is possible to select a start value (in percent) and an expected lifetime. The LED Driver adjusts the current afterwards automatically.

## 6.10 Power-up/-down fading

The power-up/-down function offers the opportunity to modify the on-/off behavior. The time for fading on or off can be adjusted in a range of 0.2 to 16 seconds. According to this value, the device dims either from 0 % up to the power-on level or from the current set dim level down to 0 %. This feature applies while operating via switchDIM, ready2mains and when switching the mains voltage on or off. By factory default no fading time is set (= 0 seconds).

## 6.11 Light level in DC operation

The LED Driver is designed to operate on DC voltage and pulsed DC voltage. For a reliable operation, make sure that also in DC emergency operation the LED Driver is run within the specified conditions as stated in chapter "4.1 operating window".

Light output level in DC operation: programmable 1 – 100 % (EOF<sub>i</sub> = 0.13). Programming by DALI or ready2mains. In DC operation dimming mode can be activated.

The voltage-dependent input current of Driver incl. LED module is depending on the used load.

The voltage-dependent no-load current of Driver (without or defect LED module) is for:  
AC: < 12.4 mA  
DC: < 4.5 mA

## 6.12 fade2zero

When the Driver is switched off, fade2zero allows a smooth dimming down to almost zero. Activate the fade2zero function when programming with companionSUITE and set a DALI fade time. fade2zero only works if the minimum dimming level of the Driver is the default value. The device then dims to far below the limit of its working window (dimming range). This function is deactivated by default.

## 6.13 Software / programming

With appropriate software and an interface different functions can be activated and various parameters can be configured in the LED Driver. To do so, a DALI-USB or ready2mains programmer and the software (masterCONFIGURATOR) are required.

## 6.14 masterCONFIGURATOR

From version 2.8:  
For programming functions (CLO, I-SELECT 2, power-up fading, corridorFUNCTION) and device settings (fade time, ePowerOnLevel, DC level, etc.). For further information see masterCONFIGURATOR manual.

## 6.15 deviceCONFIGURATOR

PC (windows) based software application to transfer parameters into our drivers. Workflow optimised for the use in OEM production line. For further information see deviceCONFIGURATOR manual.

## 7. Miscellaneous

### 7.1 Insulation and electric strength testing of luminaires

Electronic devices can be damaged by high voltage. This has to be considered during the routine testing of the luminaires in production.

According to IEC 60598-1 Annex Q (informative only!) or ENEC 303-Annex A, each luminaire should be submitted to an insulation test with 500 V<sub>DC</sub> for 1 second. This test voltage should be connected between the interconnected phase and neutral terminals and the earth terminal.  
The insulation resistance must be at least 2 MΩ.

As an alternative, IEC 60598-1 Annex Q describes a test of the electrical strength with 1500 V<sub>AC</sub> (or 1.414 x 1500 V<sub>DC</sub>). To avoid damage to the electronic devices this test must not be conducted.

### 7.2 Conditions of use and storage

Humidity: 5 % up to max. 85 %,  
not condensed  
(max. 56 days/year at 85 %)

Storage temperature: -40 °C up to max. +80 °C

The devices have to be acclimatised to the specified temperature range (ta) before they can be operated.

The LED Driver is declared as inbuilt LED controlgear, meaning it is intended to be used within a luminaire enclosure.

If the product is used outside a luminaire, the installation must provide suitable protection for people and environment (e.g. in illuminated ceilings).

### 7.3 Maximum number of switching cycles

All LED Driver are tested with 50,000 switching cycles.  
The actually achieved number of switching cycles is significantly higher.

### 7.4 Additional information

Additional technical information at [www.tridonic.com](http://www.tridonic.com) → Technical Data

Lifetime declarations are informative and represent no warranty claim.  
No warranty if device was opened.